Adapter for Beam Splitter Unit - Adapter STE60x60 - TZO71

Short description: Attachment of the STE60x60 to telecentric lenses and lightings with $d = 71\text{mm}$

Order number: 1-20-021



Characteristics

- Adapter for mounting a telecentric lens with a 71 mm front diameter on the STE60x60
 - suitable fastening material (screws and grub screws) is included in the scope of delivery
-

Technical data

Material	Aluminium, black anodised
Clamping diameter	71 mm
Weight	50 g
Adapted to:	
Telecentric optic	T201 series

Drawings

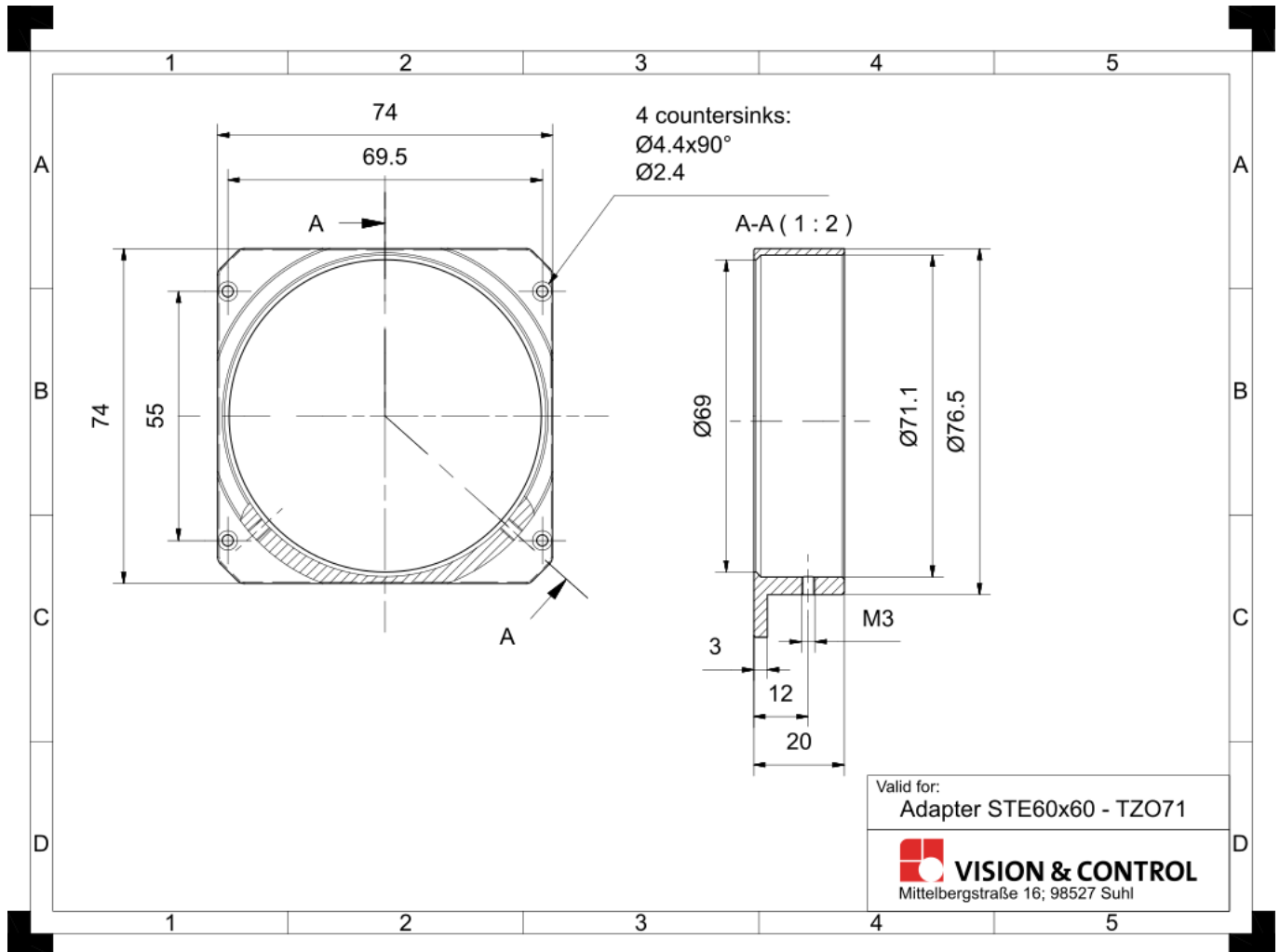

Dimensional drawing in mm