Accessory for Lighting - Cable-M5-4p-1A-angled-2m

Short description: 4x0.14mm², 1A, 60V, PUR, IP67, M5-4pin angled socket to free cable end

Order number: 1-11-105



The illustration shown is for reference, the actual product may differ.

Characteristics

- Connection cable with 4-pin M5 socket and open cable end
 - Socket: angled, plug connector with screw lock
 - open cable end: assembled, 70 cm stripped, cores crimped with wire-end ferrules
 - Length: 2 m
 - Cable structure: 4 x 0.14 mm²
 - Drag chain suitable, resistant to bending stress, strain-relieved and oil-resistant
-

Technical data

Cabel type	connection cable
Connector A	M5 socket, 4-pin, angled
Connector B	free cable end with wire-end ferrules 0.14 mm ²
Cabel	
Cable length	2 m
Cable diameter	3.2 mm
Cable structure	4 x 0.14 mm ² (AWG 26)
Sheath material	PUR
Ambient temperature	fixed: -25° to +80°C flexible: -5° to +80°C
Drag chain suitable	yes
Bending radius	fixed: 18 mm flexible: 35 mm
Bending cycles	at least 300,000
Robot-suitable	no
Length of free cable end	~ 70 mm
Connector	
Locking system	screwable
Mechanical operation	> 100 mating cycles
Rated voltage	60 V
Rated current	1 A at 40°C
Degree of protection	IP67, if connected

Drawings

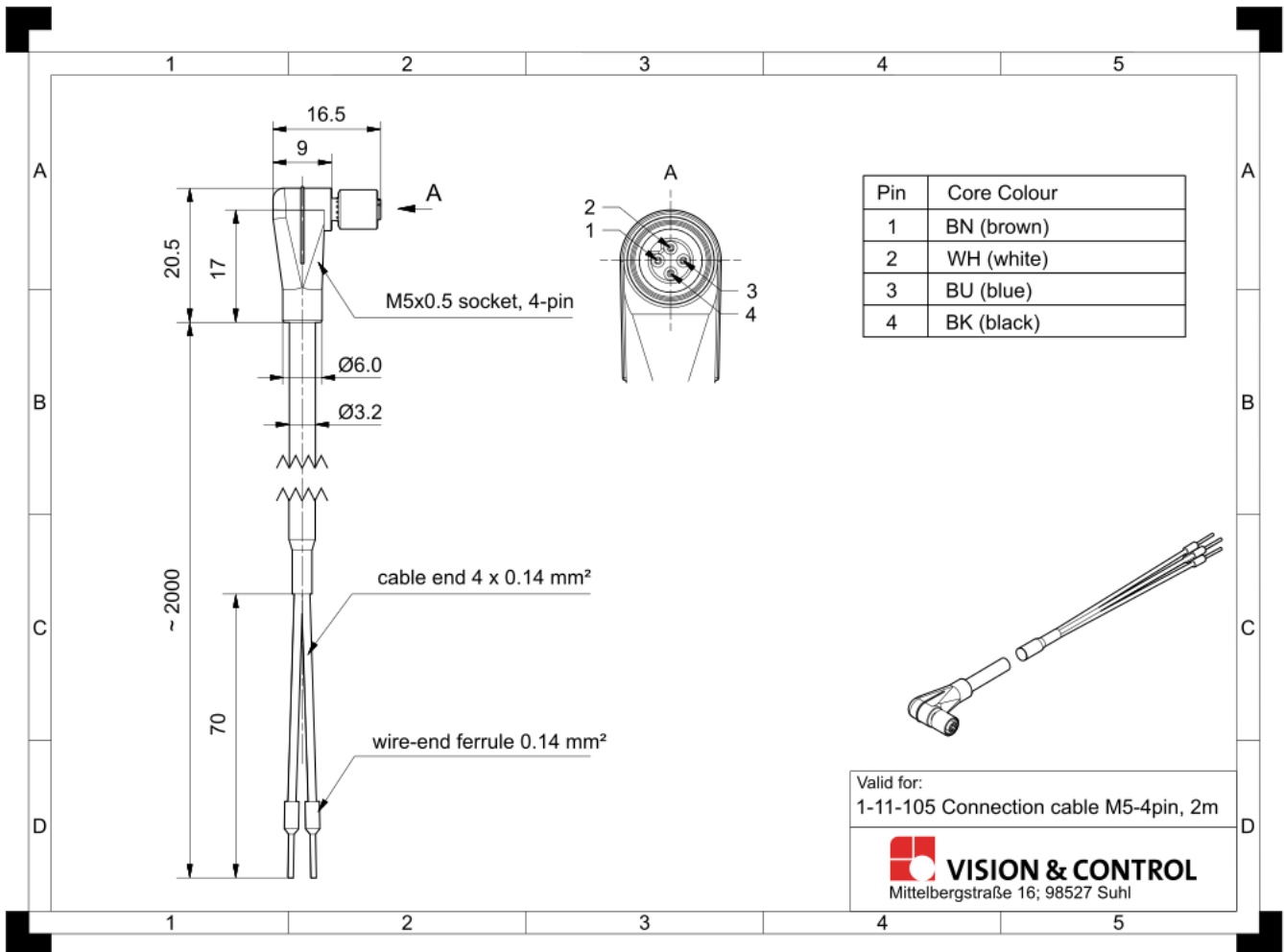

Dimensional drawing in mm