

Accessory for Lighting - Extension cable-M8-4p-5A-1.5m

Short description: 4x0.5mm², 5A, 30V, PUR, IP67, M8-4pin
straight socket to M8-4pin straight plug

Order number: 1-11-094

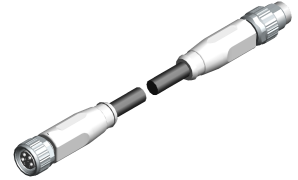

The illustration shown is for reference, the actual product may differ.

Characteristics

- Extension cable with 4-pin M8 socket and 4-pin M8 plug
 - Socket: straight, plug connector with screw lock
 - Length: 1.5 m
 - Cable structure: 4 x 0.5 mm²
 - Drag chain suitable, resistant to bending stress, strain-relieved and oil-resistant
-

Technical data

Cabel type	extension cable
Connector A	M8 socket, 4-pin
Connector B	M8-Stecker, 4-pin, straight
Cabel	
Cable length	1.5 m
Cable diameter	5.1 mm
Cable structure	4 x 0.5 mm ² (AWG 20)
Sheath material	PUR
Ambient temperature	fixed: -30° to +80°C flexible: -15° to +80°C
Drag chain suitable	yes
Bending radius	fixed: 26 mm flexible: 51 mm
Bending cycles	at least 4 million
Robot-suitable	no
Connector	
Locking system	screwable
Mechanical operation	> 100 mating cycles
Rated voltage	30 V
Rated current	5 A at 40°C
Degree of protection	IP67, if connected

Drawings

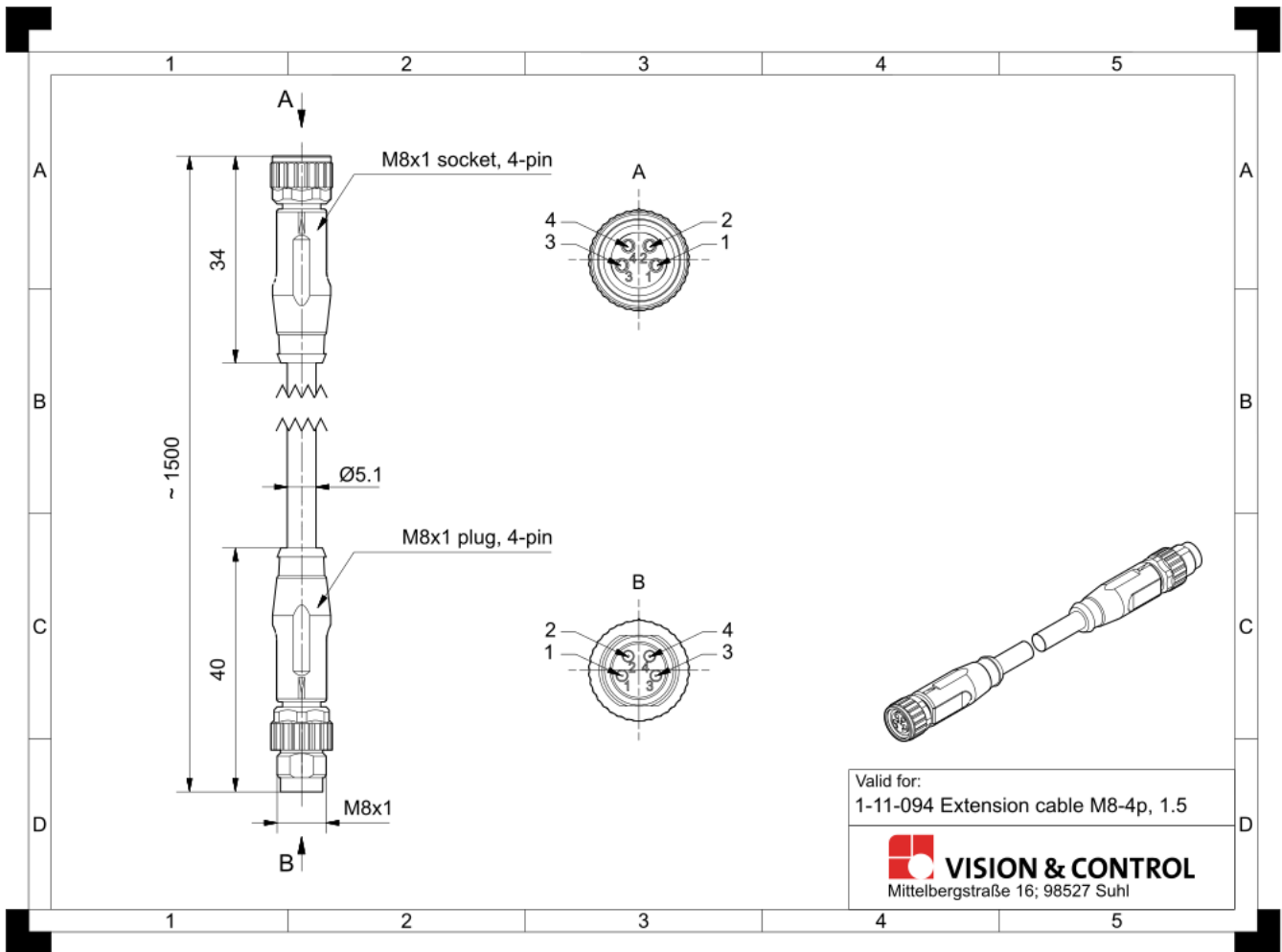

Dimensional drawing in mm